

Technical Data Sheet



Clearline Vetro Solar Thermal Glazing Cassette

Description

The Clearline Vetro family of solar heating panels install directly into vertical and sloping glazing systems as easily as a sheet of glass to produce an integrated aesthetic that matches adjacent glazed panels.

Model		CV15	CV20	CV30
Nominal Area	m ²	1.5	2.0	3.0
Absorber Area	m ²	1.49	2.10	3.05
Zero Loss Efficiency (η_0) ^ψ		0.81	0.81	0.81
Heat Loss Coefficient (a_1) ^ψ	W/m ² K	3.9	3.9	3.9
Rated Flow	litres/h	75	100	150
Pressure Drop at Rated Flow	MPa	7.0	12.1	34.2
Weight (empty)	kg	39	53	78
Weight (filled)	kg	40	55	80
Minimum Panel Length	mm	1,514	2,078	2,927
Minimum Panel Width	mm	1,202		
Height	mm	82		
Glass Thickness	mm	6.0		
Maximum hydraulic pressure	bar	3.0		
Warranty	years	10		

^ψ These figures are indicative based on Clearline solar panels

Efficiency Curve ^ψ



Pressure Curve

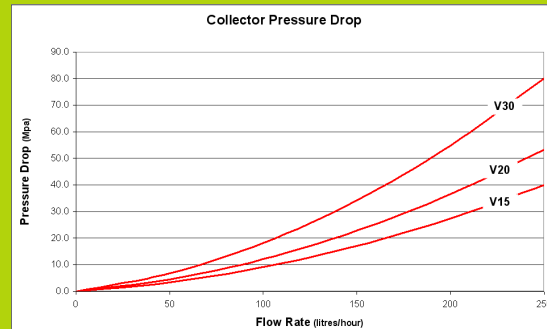

Installation

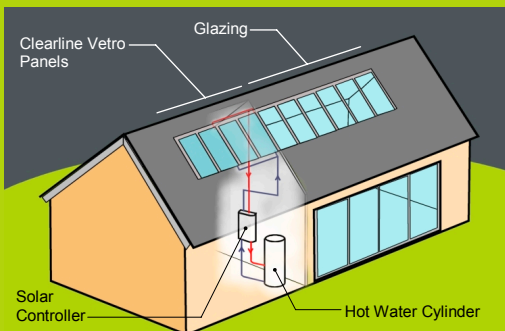

The panels are fitted by a specialist glazing installation company. Where the glazing bar spacing is 600mm, dummy glazing bars can be fitted down the centreline of the panels.

Plumbing connections are made from inside the building. A pair of insulated pipes run from the panel to the supplied control set, and on to the hot water cylinder.

In common with other types of solar water heating the greater part of the hot water use in the building during the year can be supplied, but an auxiliary heat source (immersion heater or boiler) will be necessary to achieve hot water on days with low solar energy.

Application

Solar water heating is most appropriate for buildings with significant hot water demand - for example residential property, hospitals and surgeries, sports facilities and hotels.

Clearline Vetro Solar Thermal Glazing Cassette

Dimensions

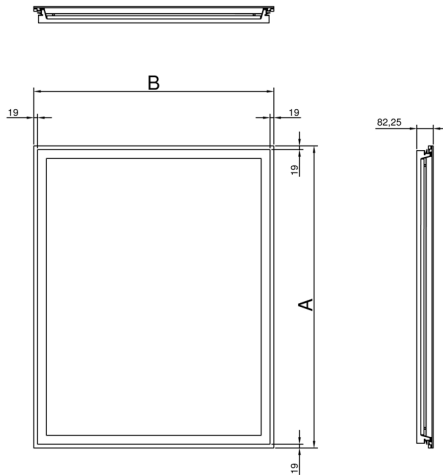

Model		CV15	CV20	CV30
A	mm	1514	2078	2927
B	mm	1202	1202	1202

The dimensions given are based on the minimum glass overhang of 19mm. Larger glass dimensions are available.

Curtain Walling - Four Edge Support

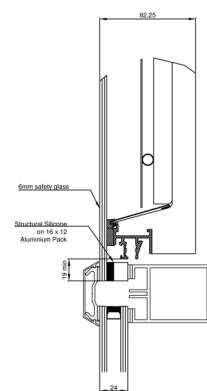
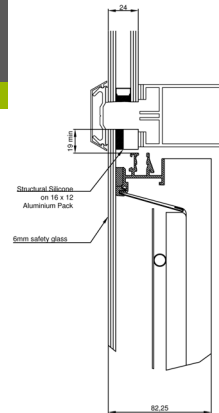
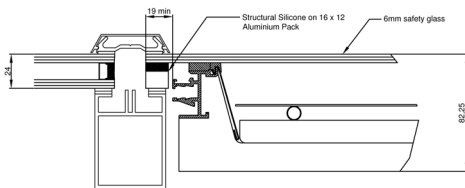
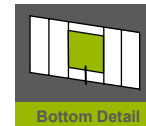
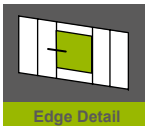

Sloping Roof Glazing - Two Edge Support

